

Capítulo 31 (Revolver)

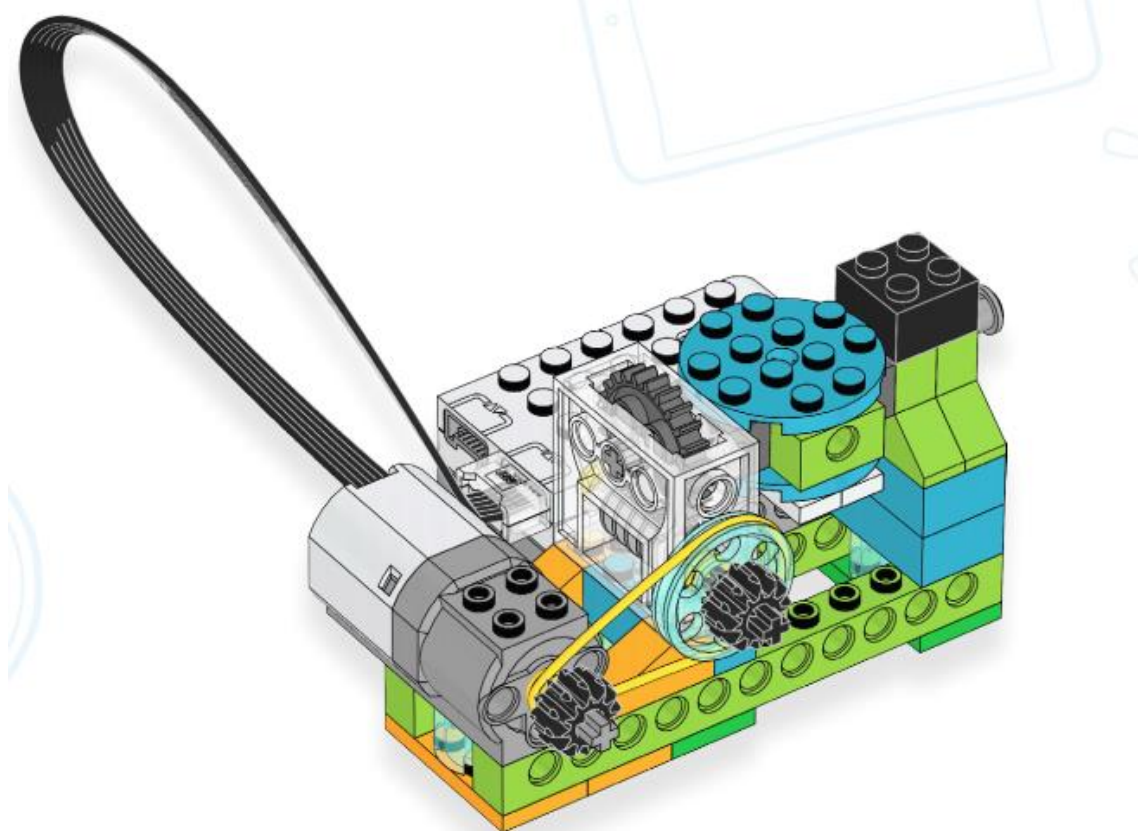

Este capítulo se puede realizar con un solo Kit.

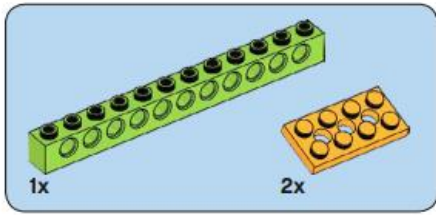

1

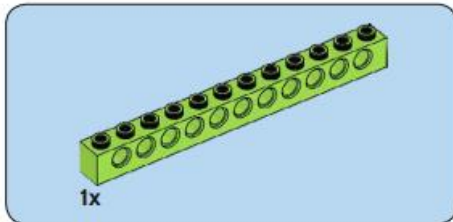
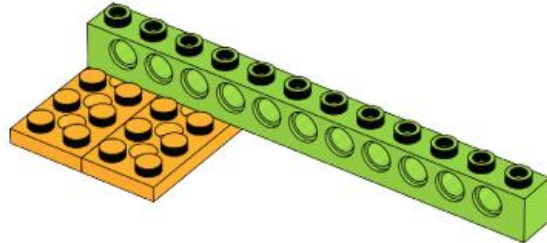

2

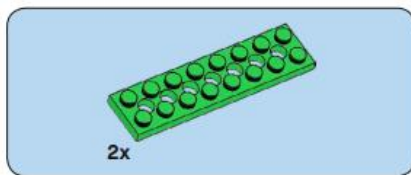
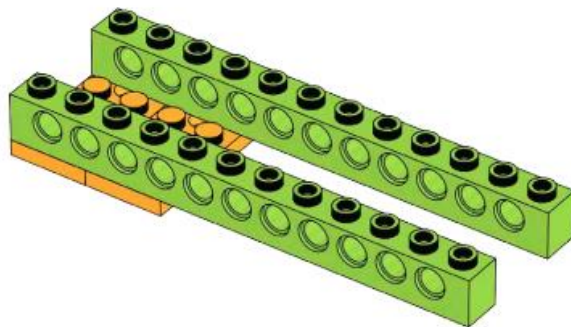

3

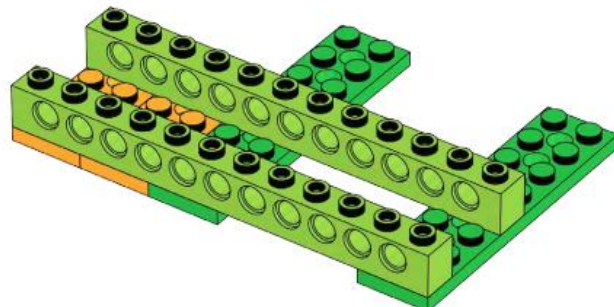



4

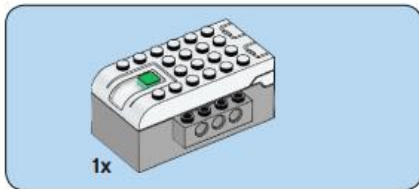
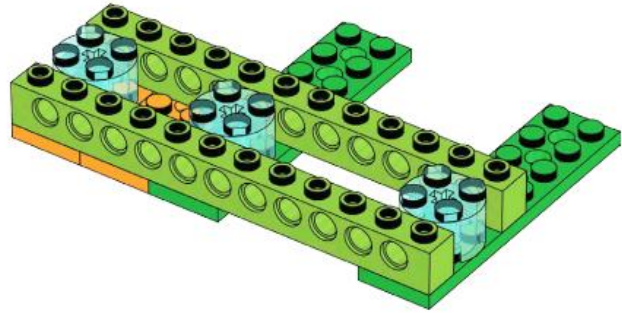

5

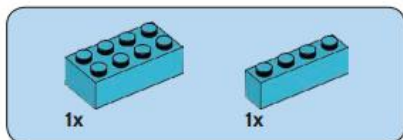
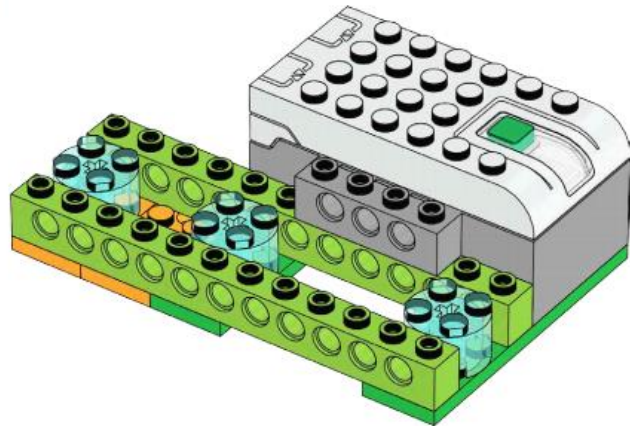

6

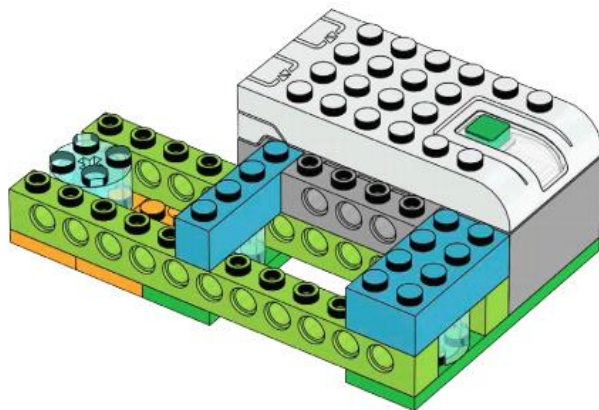

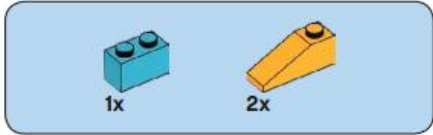

7

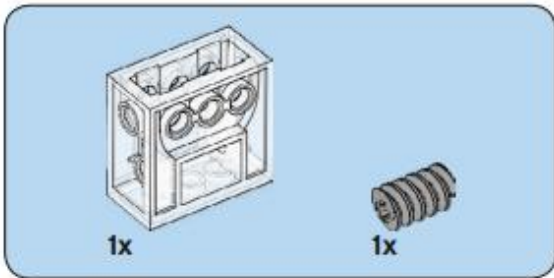
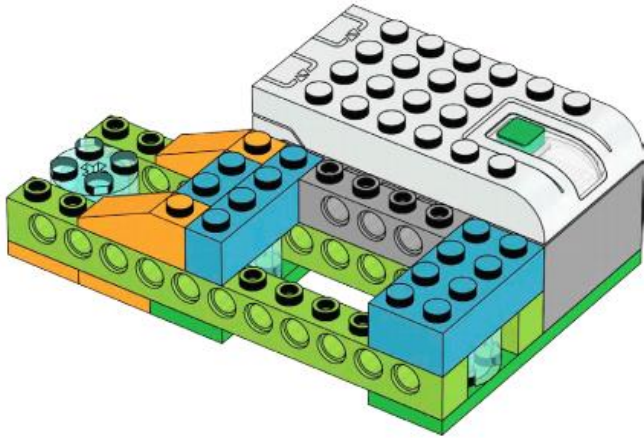

8

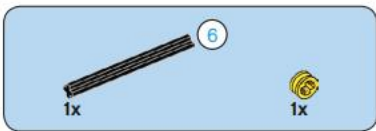
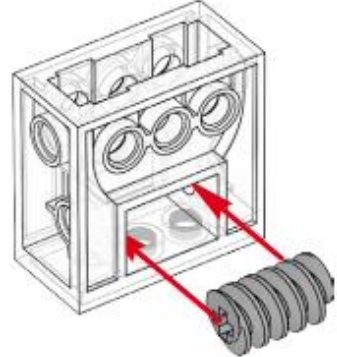

9

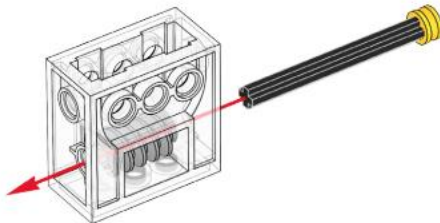



10

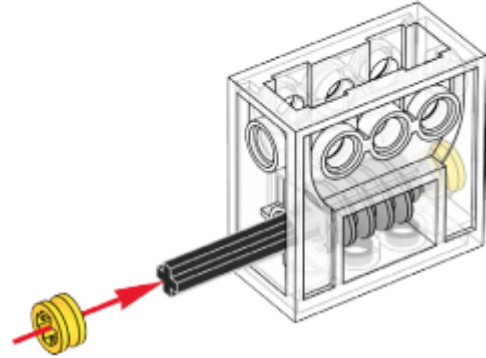

11

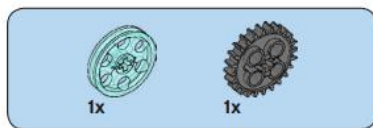
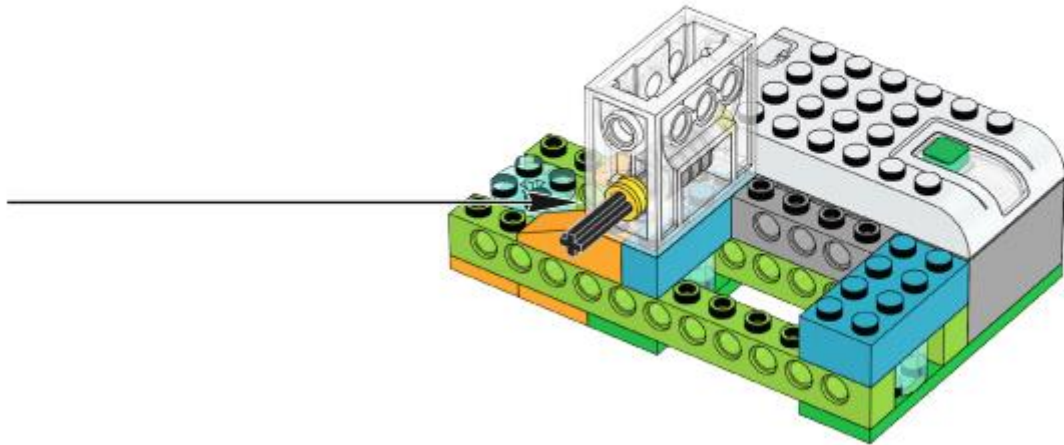

12

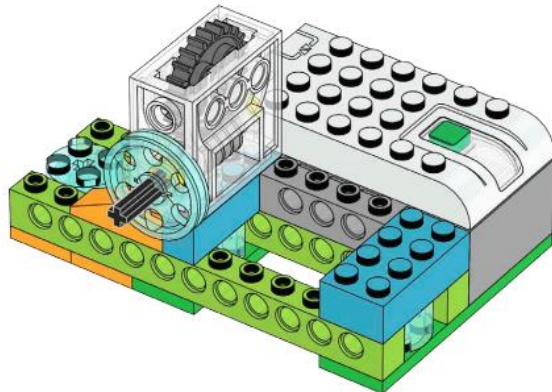



13

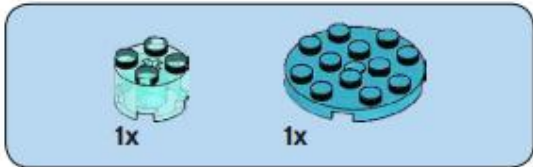
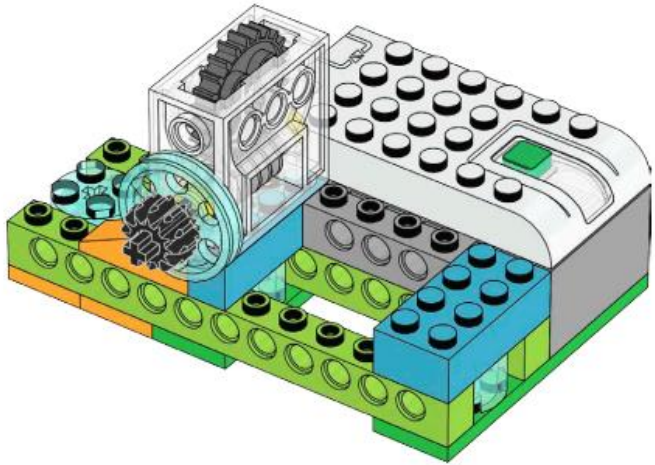

14

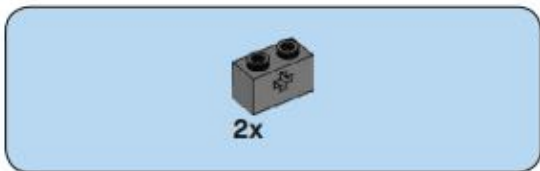

15

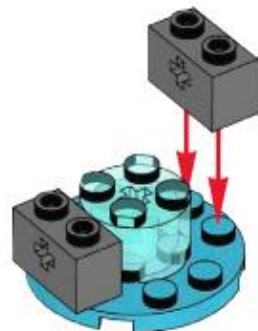

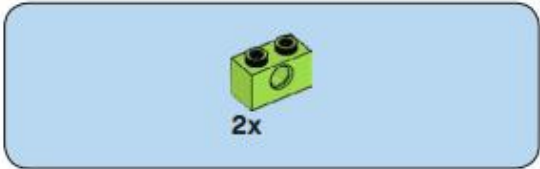

16

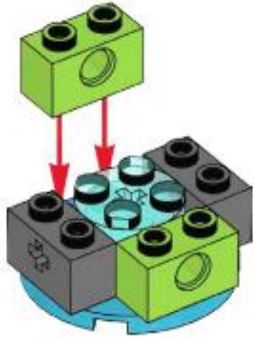

17

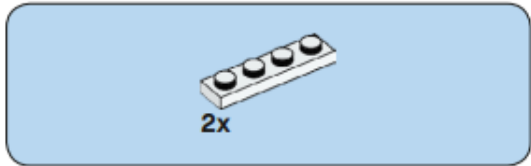
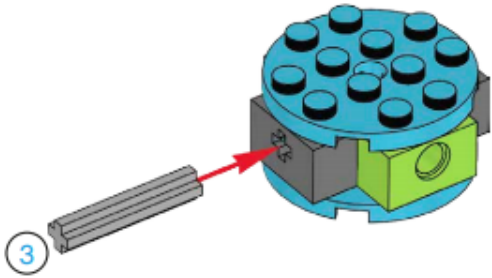

18

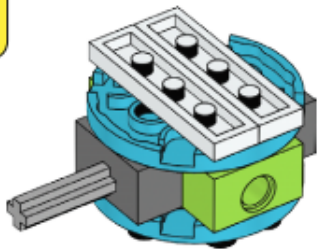

19

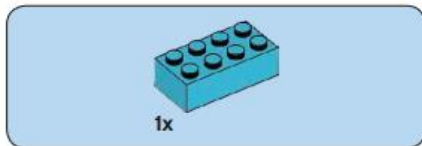
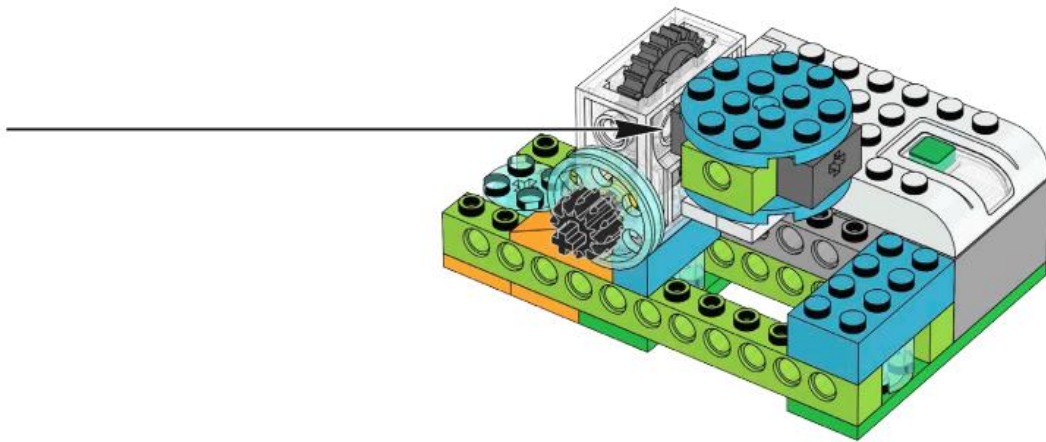

20

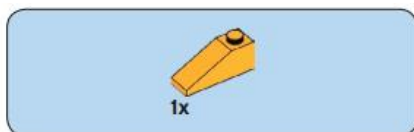
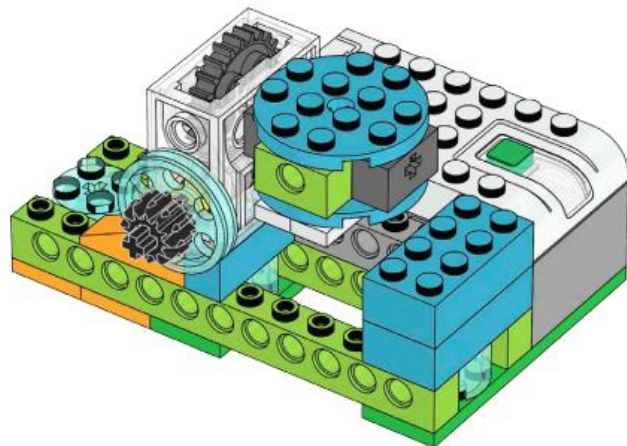

21

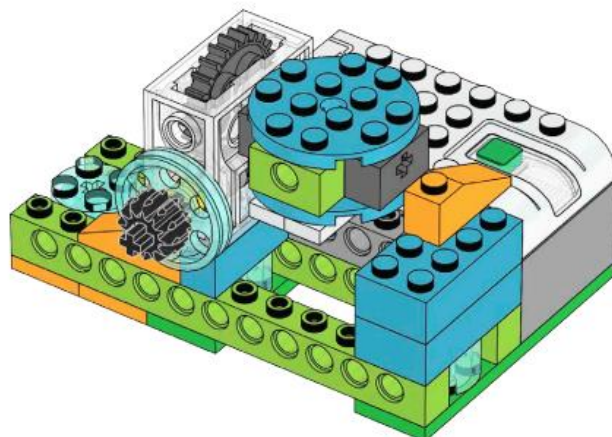

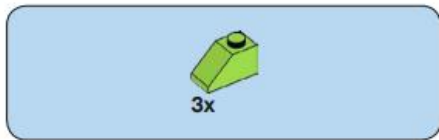

22

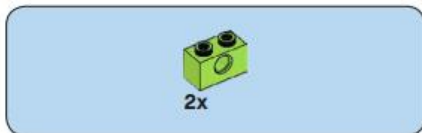
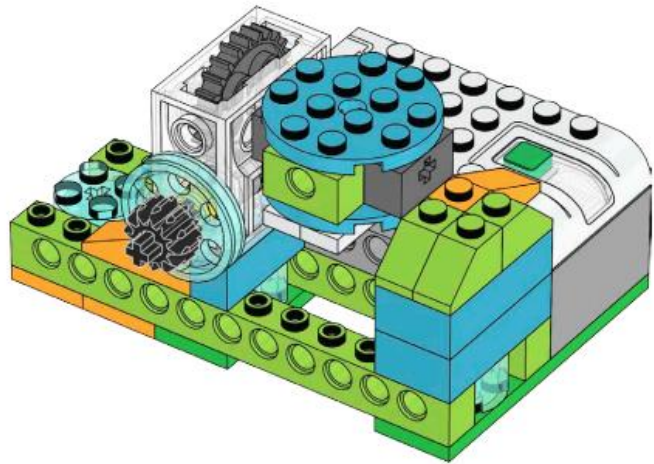

23

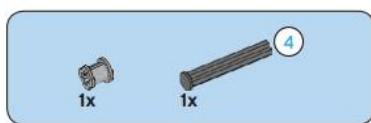
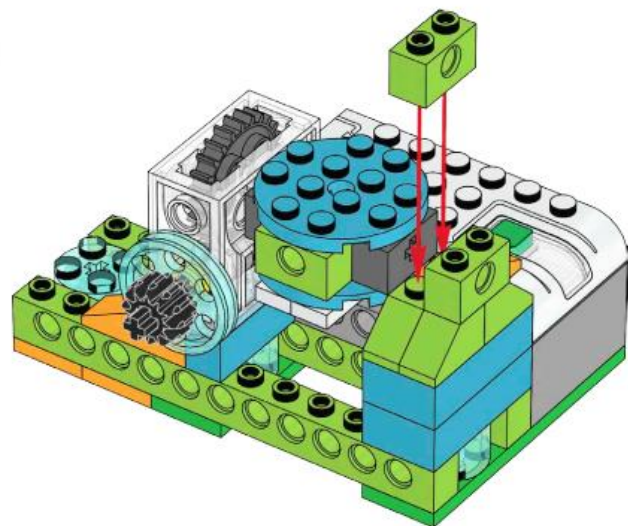

24

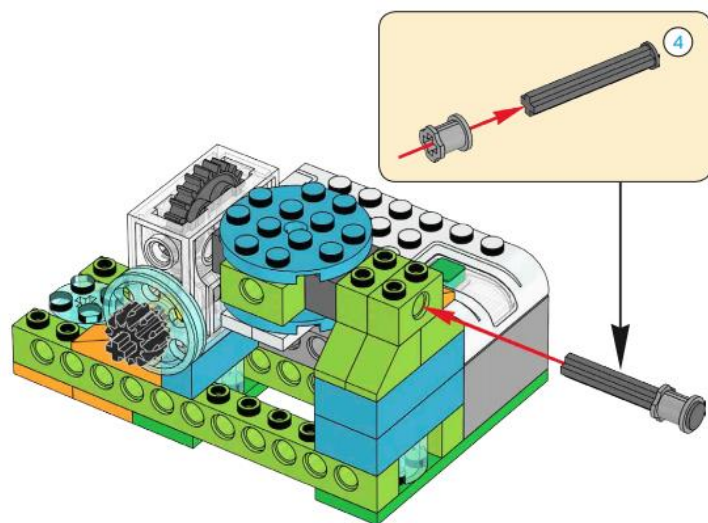

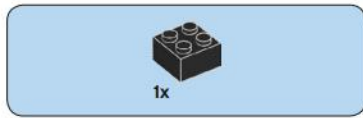

25

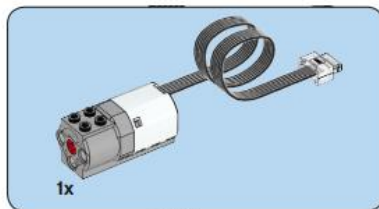
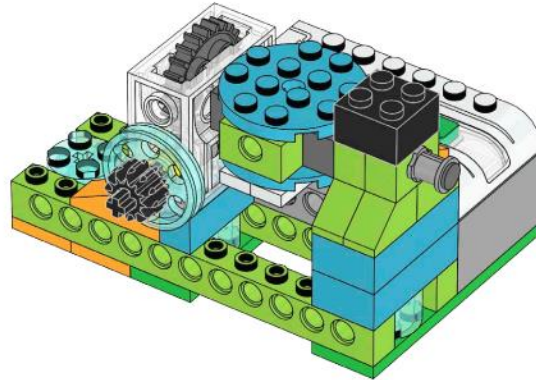

26

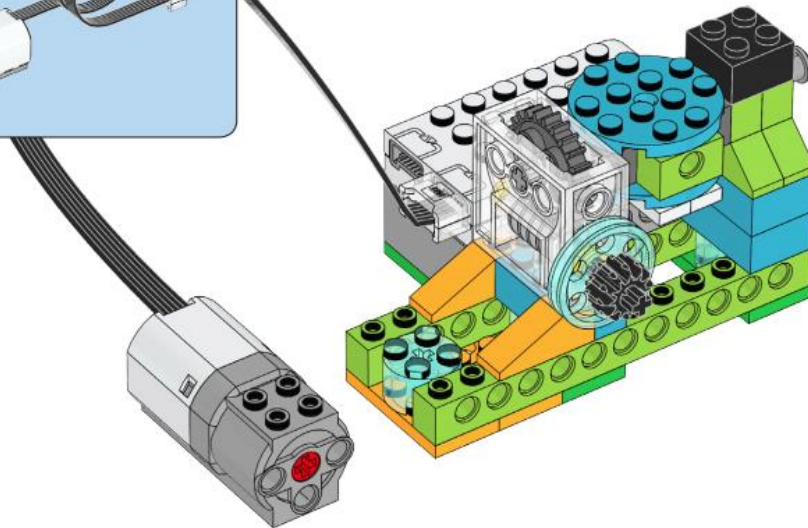

27

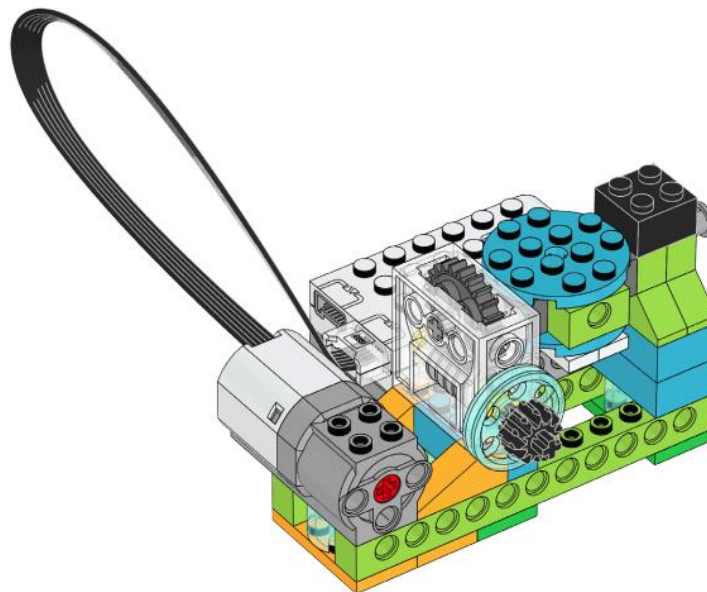

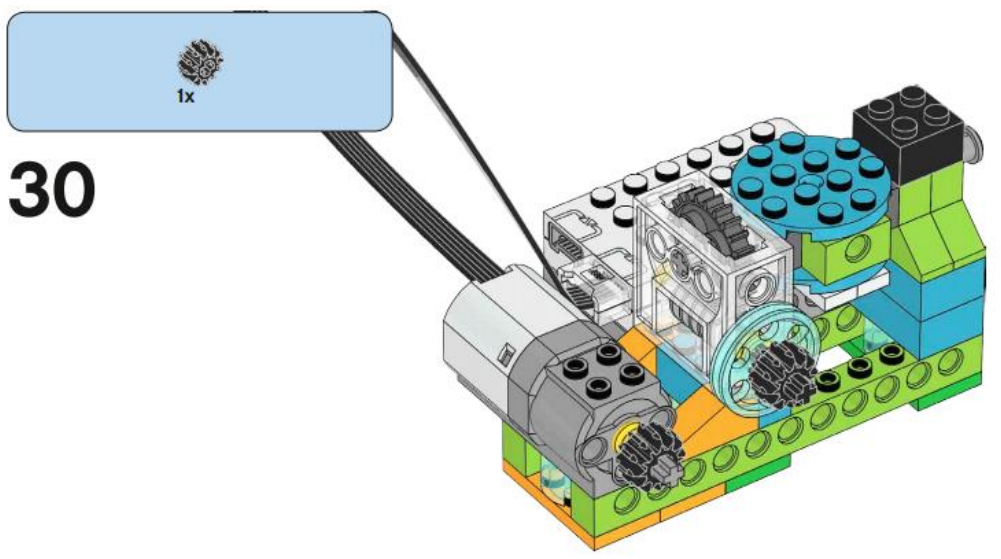
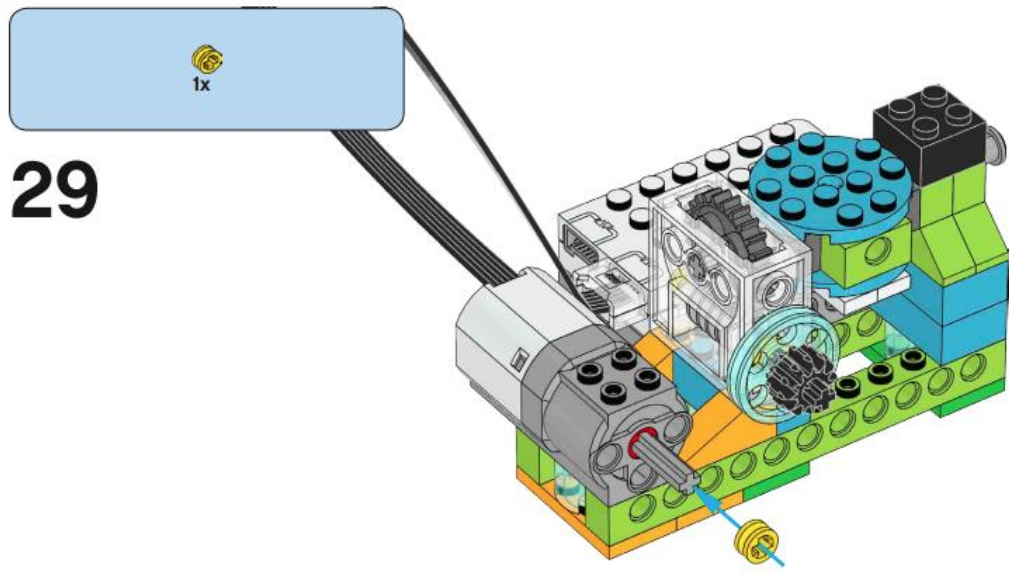
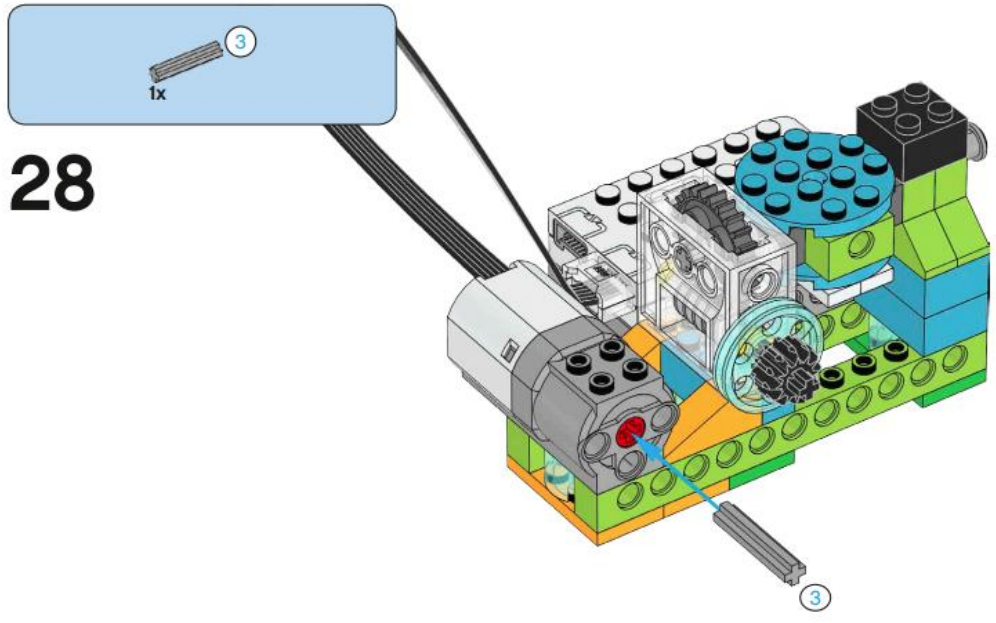

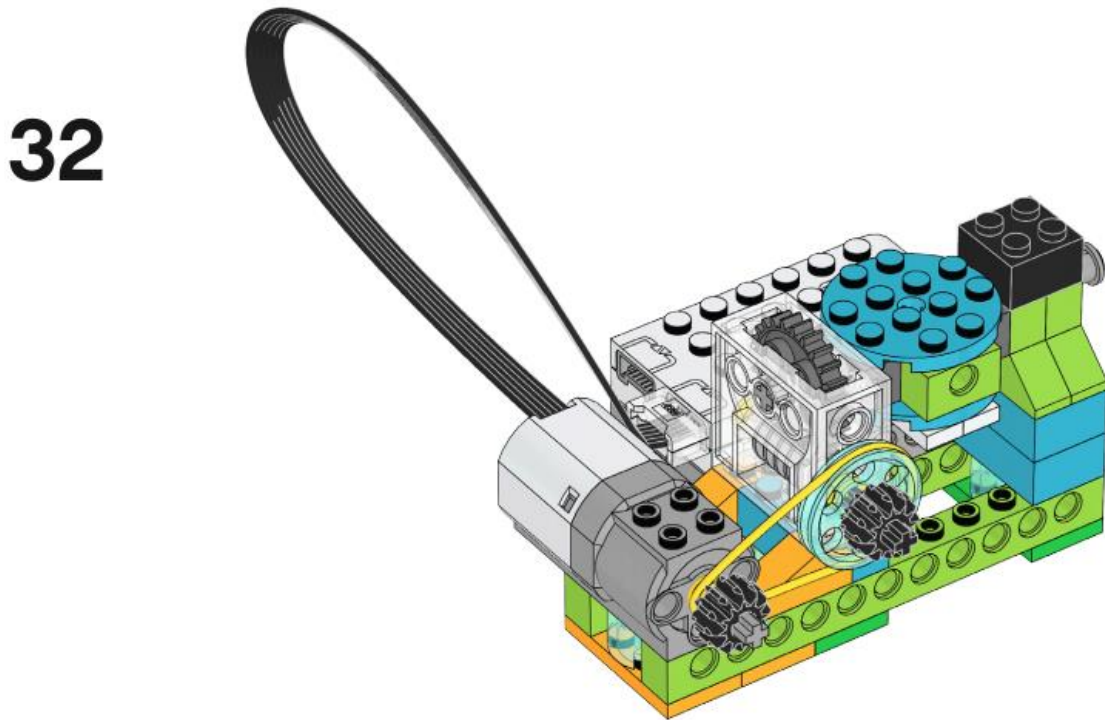
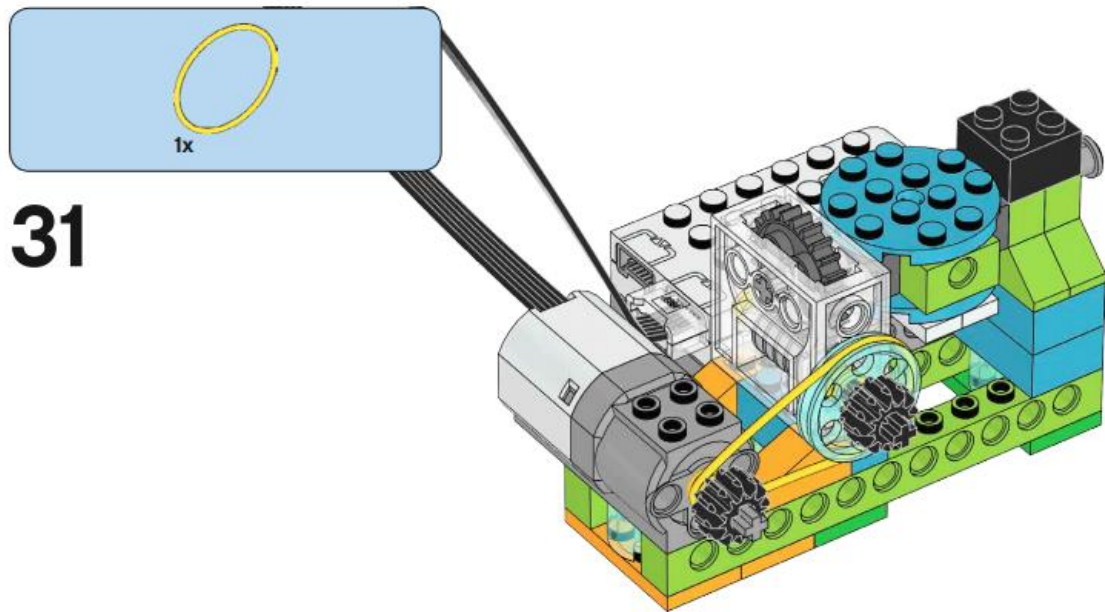

En este capítulo vamos a utilizar bloques, con esta opción nos evita tener que escribir código que se repite en el programa.

Codificación

